

DriveDOCK Extreme Installation set up

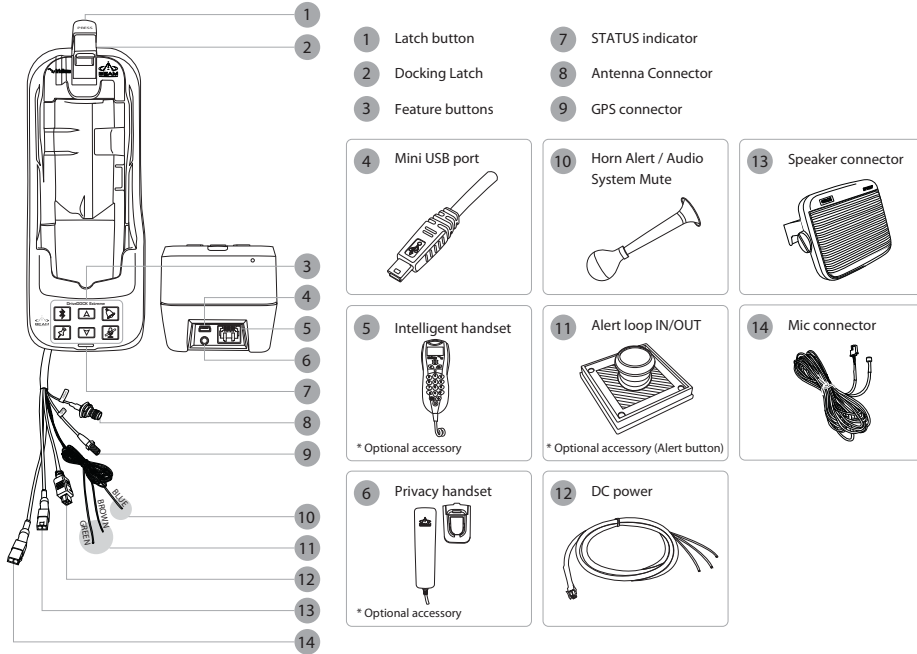

Options

Tracking & Alert

Tracking & alert requires the GPS antenna and setup of the tracking and/or alerting messages in Eagle and in the Iridium Extreme Handset.

External Alert Loop Button:

Connect a Normally-CLOSED button, to the Brown and Green wires (it can be extended for longer runs).

The loop needs to be OPEN (press button) for 2 seconds to activate Alert (SOS) mode.

Privacy Handset:

- Mount the handset cup to the mounting plate.
- Mount the spacer plate and the mounting bracket, by using the longer screws provided with the kit. (Re-installed the RAM arm-bracket behind these plates).
- Connect the Privacy Handset 3.5mm plug into the socket at the base of the DriveDOCK Extreme
- Privacy Handset mode is active whenever the handset is removed from the cup.

Intelligent Handset:

- Mount the handset cup in a suitable position
- Connect the Intelligent handset RJ45 connector into the RJ45 socket at the base of the DriveDOCK Extreme
- Intelligent handset mode is active whenever the handset is removed from the cup

BEAM Communications Pty Ltd

8 Anzed Court, Mulgrave
Victoria, 3170, AUSTRALIA

Tel: +61 3 8588 4500

Fax: +61 3 9560 9055

Info: info@beamcommunications.com

Support: support@beamcommunications.com

www.beamcommunications.com



Mounting Cradle

The DriveDOCK Extreme is supplied with a universal RAM® mount bracket that enables mounting to any flat surface (vertical or horizontal) within a vehicle, or other required location.

1. Attach one pivot base to the rear of the DriveDOCK Extreme using the M4 screws and washers supplied.
2. Secure the second pivot base to the location you have selected for mounting the DriveDOCK Extreme. (Screws not supplied)
3. Use the interconnecting arm of the RAM® mount to secure the DriveDOCK Extreme to the pivot base and tighten into the desired location firmly using the wing nut on the arm.

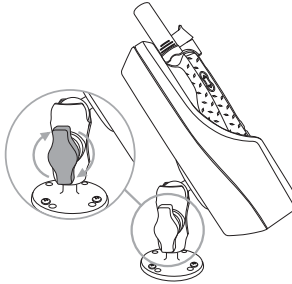
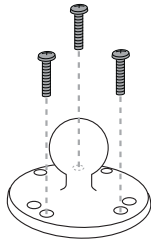
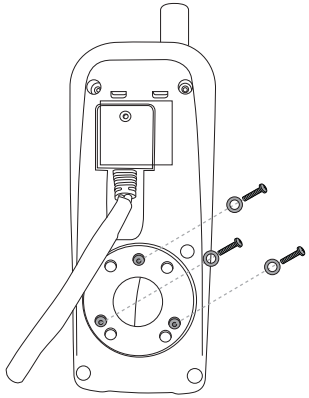

Inserting and Ejecting Extreme Handset

Inserting:

1. At the base of the Iridium Extreme handset there is an accessory connector cover. Open the cover and move it to the back of the handset, securing it to the two rear retaining features.
2. Press down the latch button and then gently rotate it up to open the latch. Place the Iridium Extreme handset into the DriveDOCK Extreme.

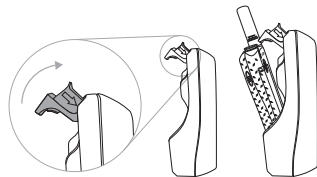
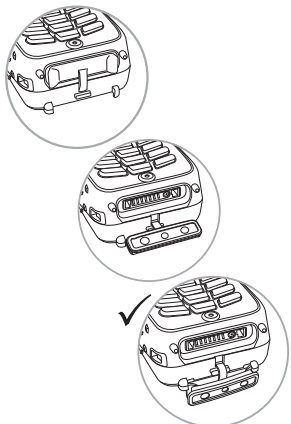

3. Lift the latch back over the handset until it Click's into place.

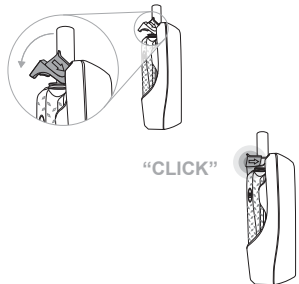

Removing:

1. To remove the handset, first press the eject button and then rotate the latch up away from the handset. The handset can now be slid up and out of the DriveDOCK. Refit the accessory connector cover to maintain the IP rating of the Iridium Extreme handset.

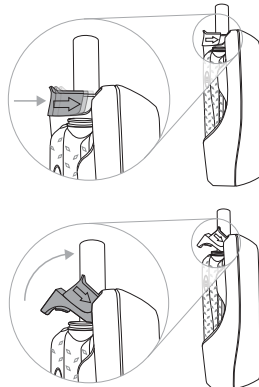

Iridium Antenna Connection

The antenna connections exit from the rear of the DriveDOCK Extreme cradle, via the antenna loom. There are two RF connections required, the Satellite TNC Female Connector and GPS SMA Female connector.

Refer to the antennas installation guide for antenna mounting and location requirements.



WARNING

DO NOT pull with force on the cables from the rear of the DriveDOCK. Please install strain relief clamping for the antenna cables where required.

Correct installation of the antenna system is a vital part of the DriveDOCK DRIVE system, to ensure reliable functionality, and drop-free calls.

DriveDOCK Extreme Front Panel

LOCATION	BUTTON MODE	ACTION	LED/SOUND
	Mute press On/off	In a Call: Mute the microphone (uplink) on the Hands-free, optional privacy handset, or optional Intelligent Handset	LED turns RED Muted LED turns OFF Not muted
	Up/Down OR 	In a Call: Increase/decrease volume on the audio device in use Out of Call or Incoming Ring: Increase/decrease volume of incoming ring tone on the external or internal speaker. (The lowest setting will silence the Ringer) Brightness Mode: Increase/decrease the LED intensity	Audio will sound louder/quieter with each press. A beep will sound indicating the increased/decreased ring tone volume of the external or internal speaker – whichever is currently set by the Ring (Bell) button. All Button LEDs will be increased/decreased with each press.
	Brightness - dual button simultaneous press (2 seconds) +	Out of Call: Enter LED brightness change mode. Then Press UP and/or DOWN arrows to vary intensity.	Status LED flashes YELLOW 3 times and all Button LED's will change WHITE. A single beep will sound when entering brightness change mode. A short double beep will sound when exiting change mode.
		Mode will automatically exit after 5 seconds after the last button press.	
	Ringer Single Press	Not in Call: Cycle through the ring tones and the output device (internal buzzer and external speaker). The last Ringer type sounded is then saved.	Ring tone playback and the output device changes. LED FLASHING (Fast) BLUE when Ring Tone is sounded.
	Single Press (no beep sound)	When Bluetooth is OFF: Turns ON Bluetooth function	LED changes from OFF to FAST FLASHING in BLUE when searching Bluetooth device(s). LED turns solid BLUE when connected
		If Bluetooth connected but NOT used in Call: Transfer the audio to the Bluetooth device	LED changes from Solid BLUE to SLOW FLASHING in BLUE
		Bluetooth Device being Used in Call: Transfer the audio to HF mode, or Privacy/Intelligent handset if activated	LED changes from Slow Flashing to solid BLUE
	Single Press 1.5 sec (until 1 beep sounds)	Bluetooth function is ON: Turns OFF Bluetooth function	LED turns OFF
	Single Press 5 sec (until 2 beep sounds)	Bluetooth function is ON: Bluetooth is set to discovery mode for pairing to Bluetooth devices	LED is FAST FLASHING ORANGE and BLUE, and then turns solid BLUE when paired and connected.
	Single Press 10sec (until 3 beep sound)	Bluetooth is ON or OFF: Clear all paired Bluetooth devices and turn off Bluetooth function	LED turns OFF
	Single Press (until 1 beep sounds)	In Tracking Mode*: Send a Quick GPS message to the pre-configured destination in the Extreme Handset	LED flashes GREEN for 5 seconds. A beep will sound to indicate that a tracking message is to be sent#
	Single Press 5sec (until 2 beeps sound)	Enables / Disables Track button	LED Solid GREEN is enabled, LED OFF is disabled

* This action is optional, and only when tracking for your Extreme Handset is configured and activated. Using the Track button only initiates the command to send a Quick GPS message - check that the Extreme Handset is configured correctly.

A beep will only sound if audible alerts are enabled in Eagle